

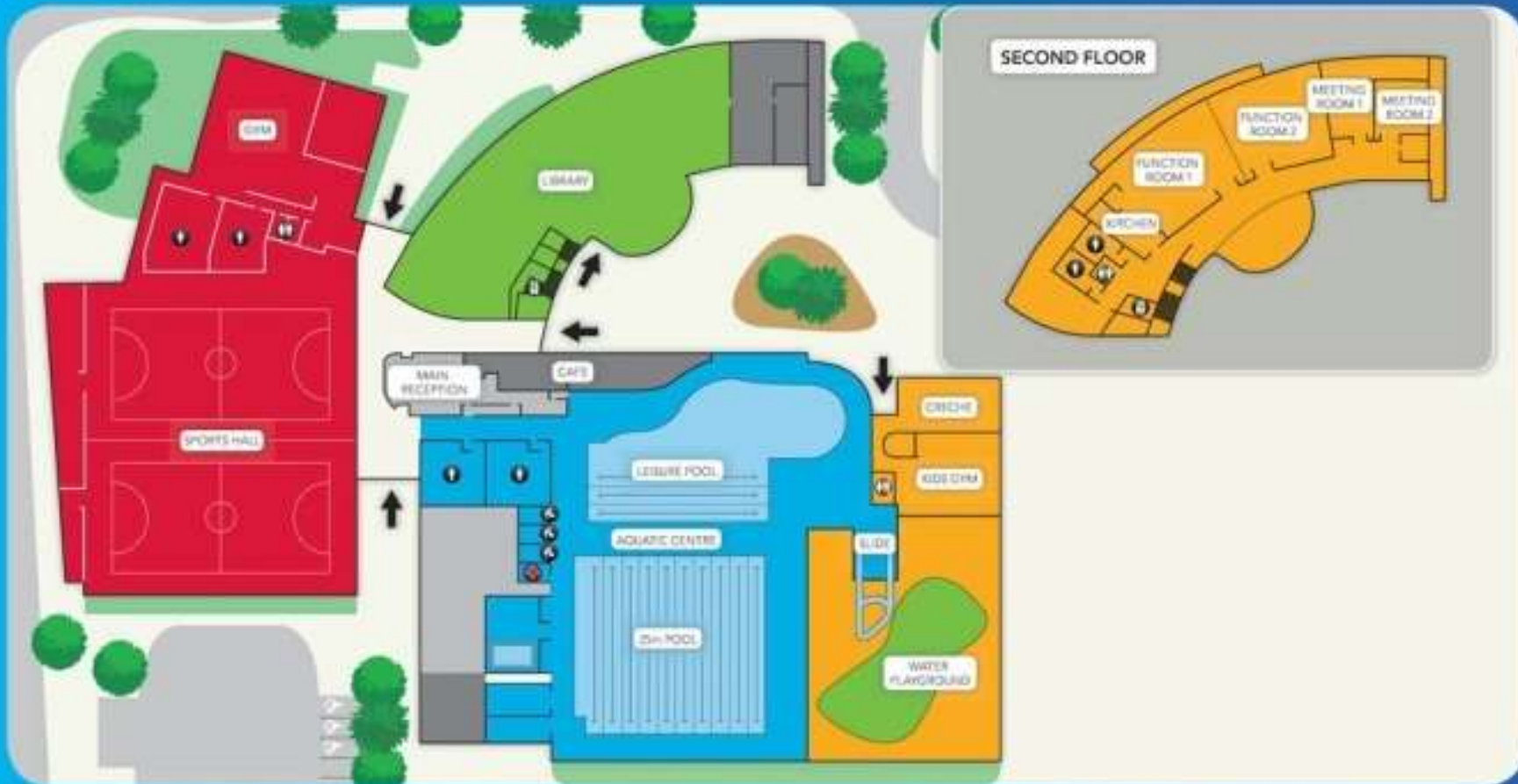

  
Cannington  
Leisureplex

Welcome



**GYM**  
20°C

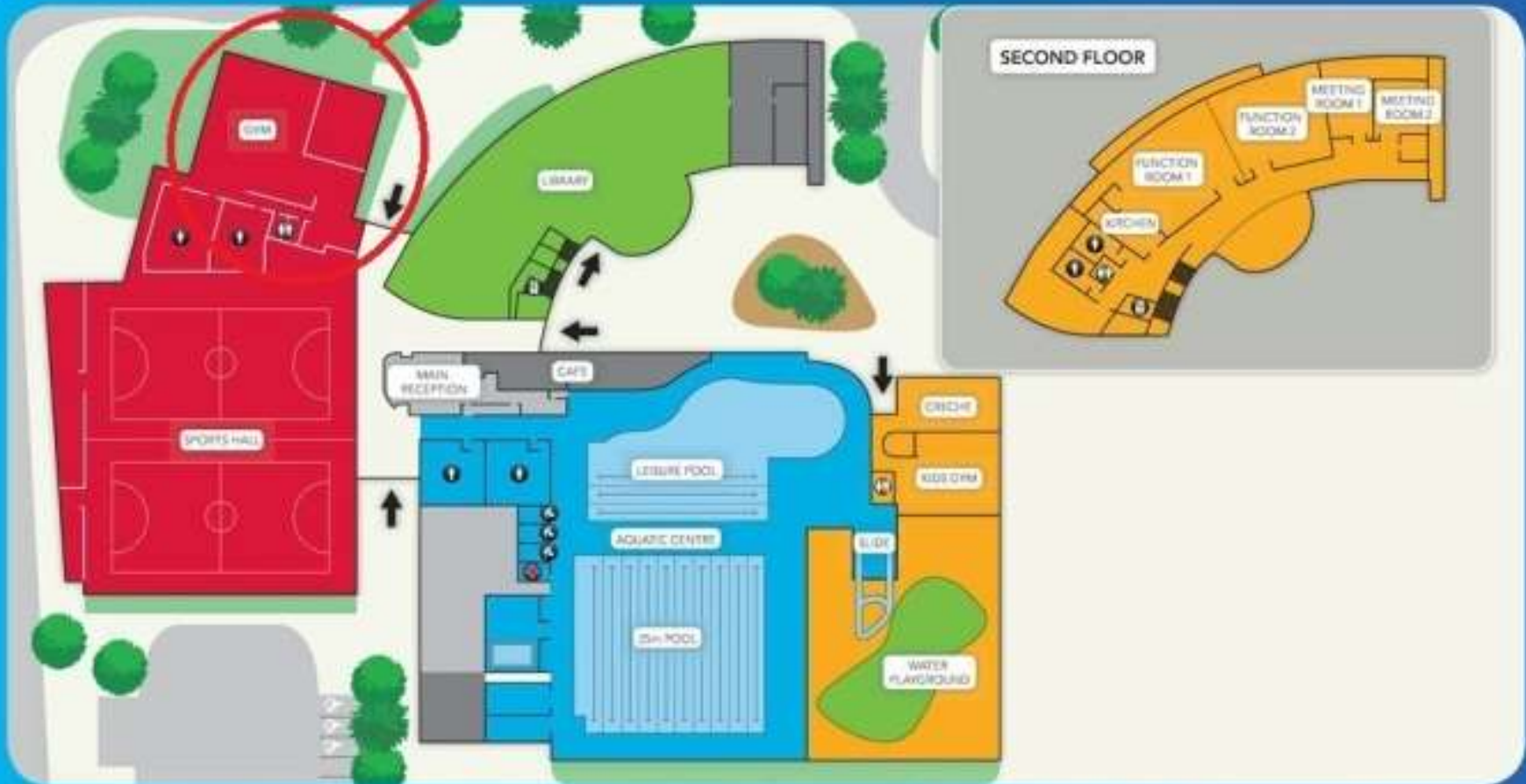

# SPORTS HALL

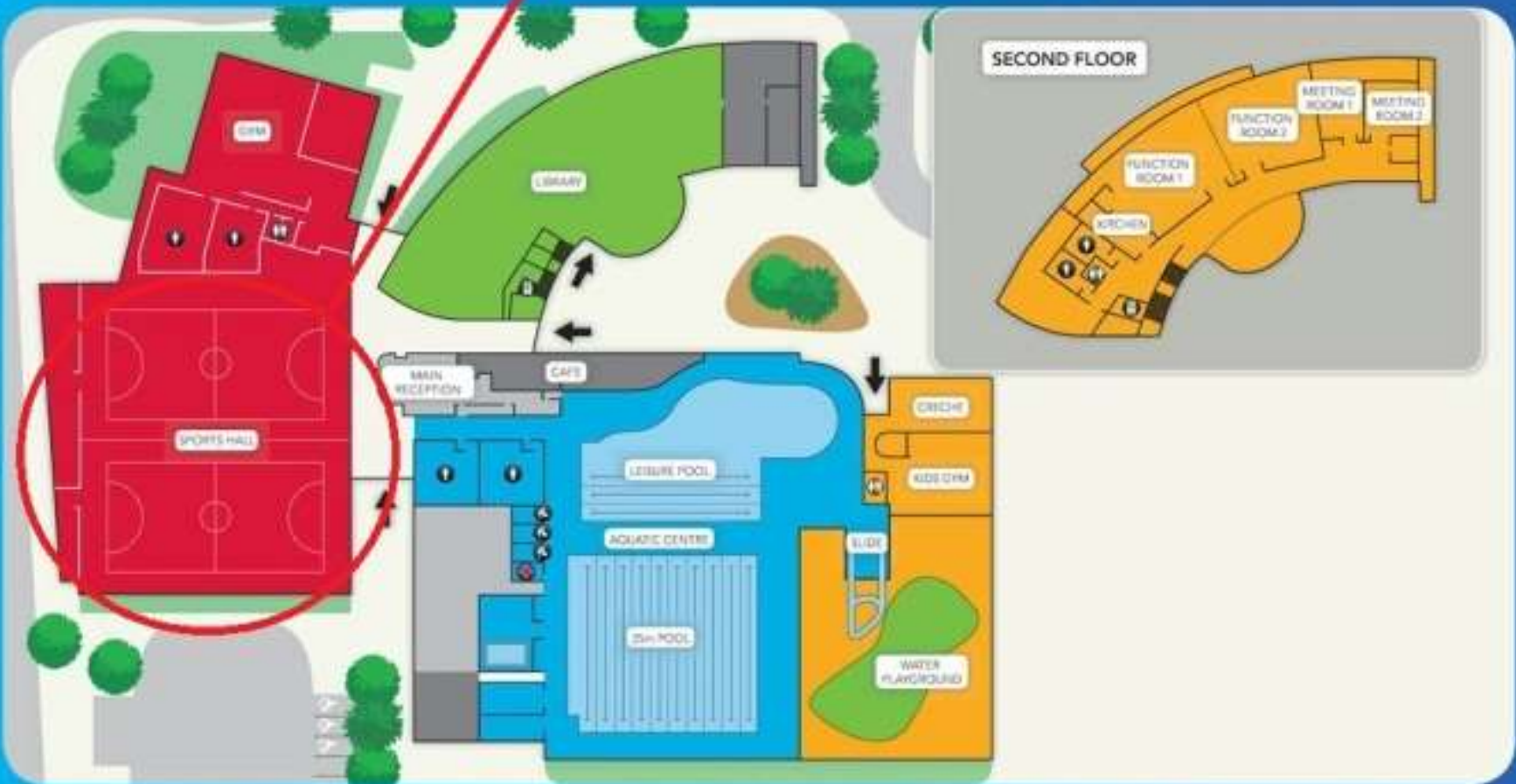

LIBRARY  
23°C

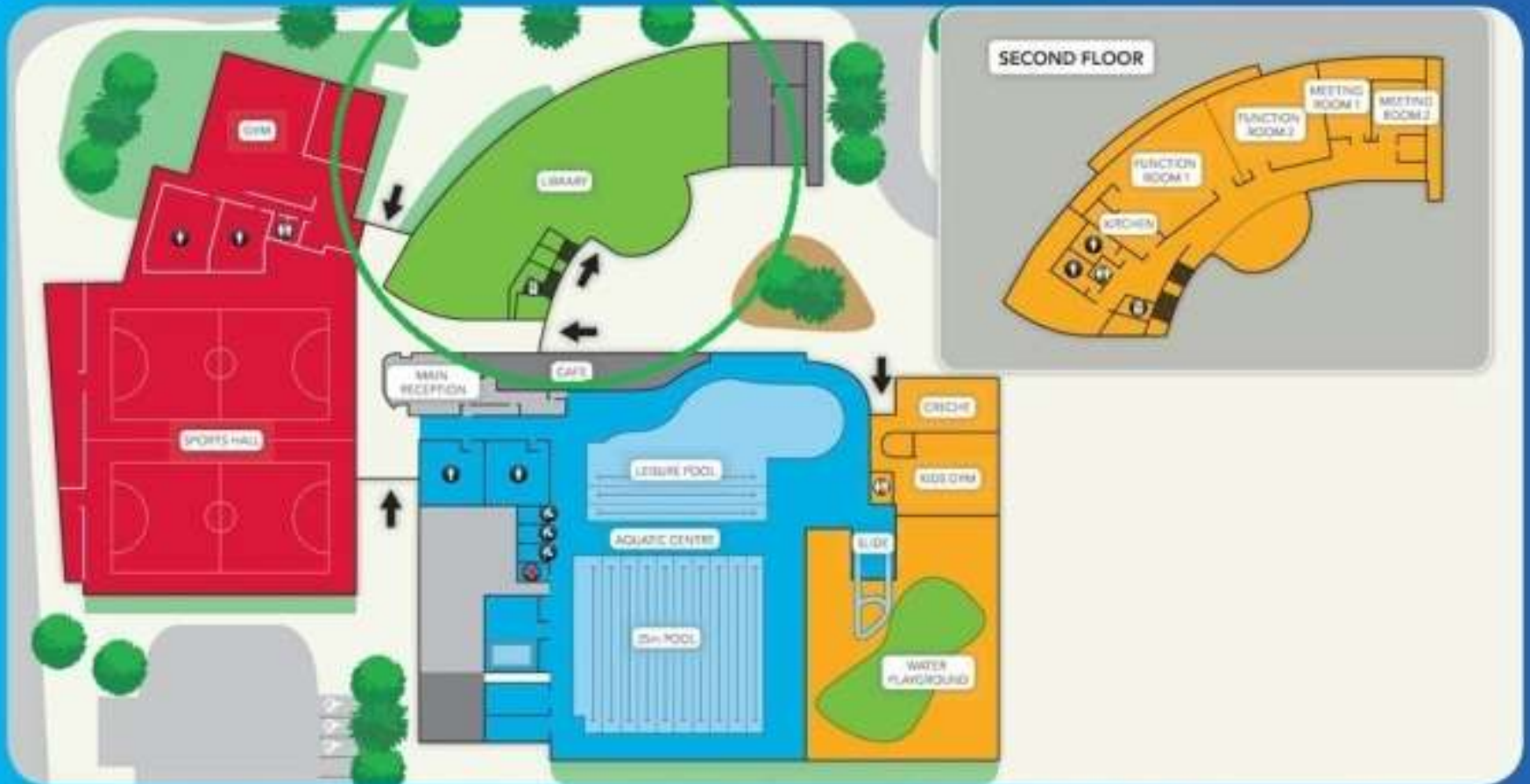

# FUNCTION CENTRE 22°C

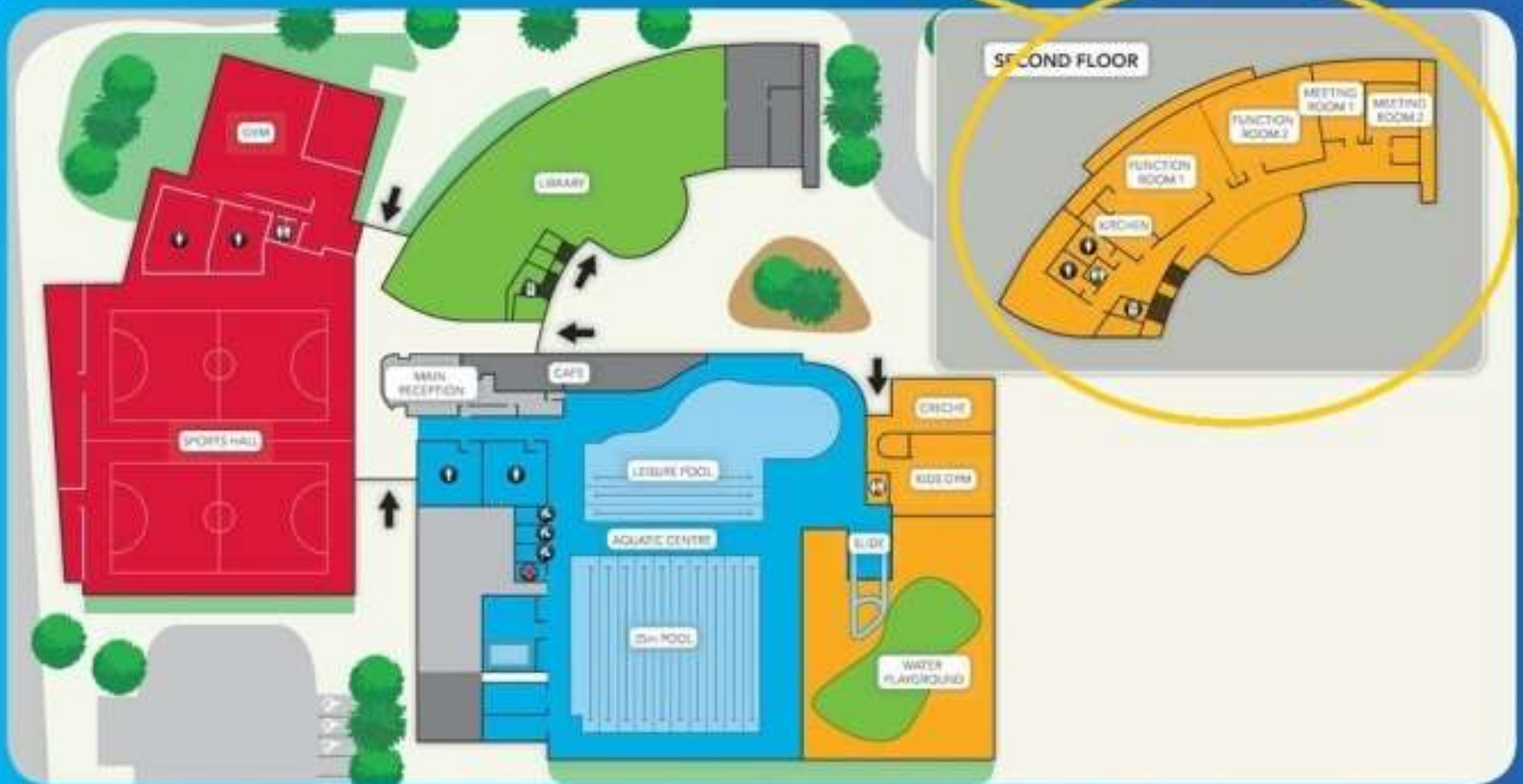

CRECHE  
23°C

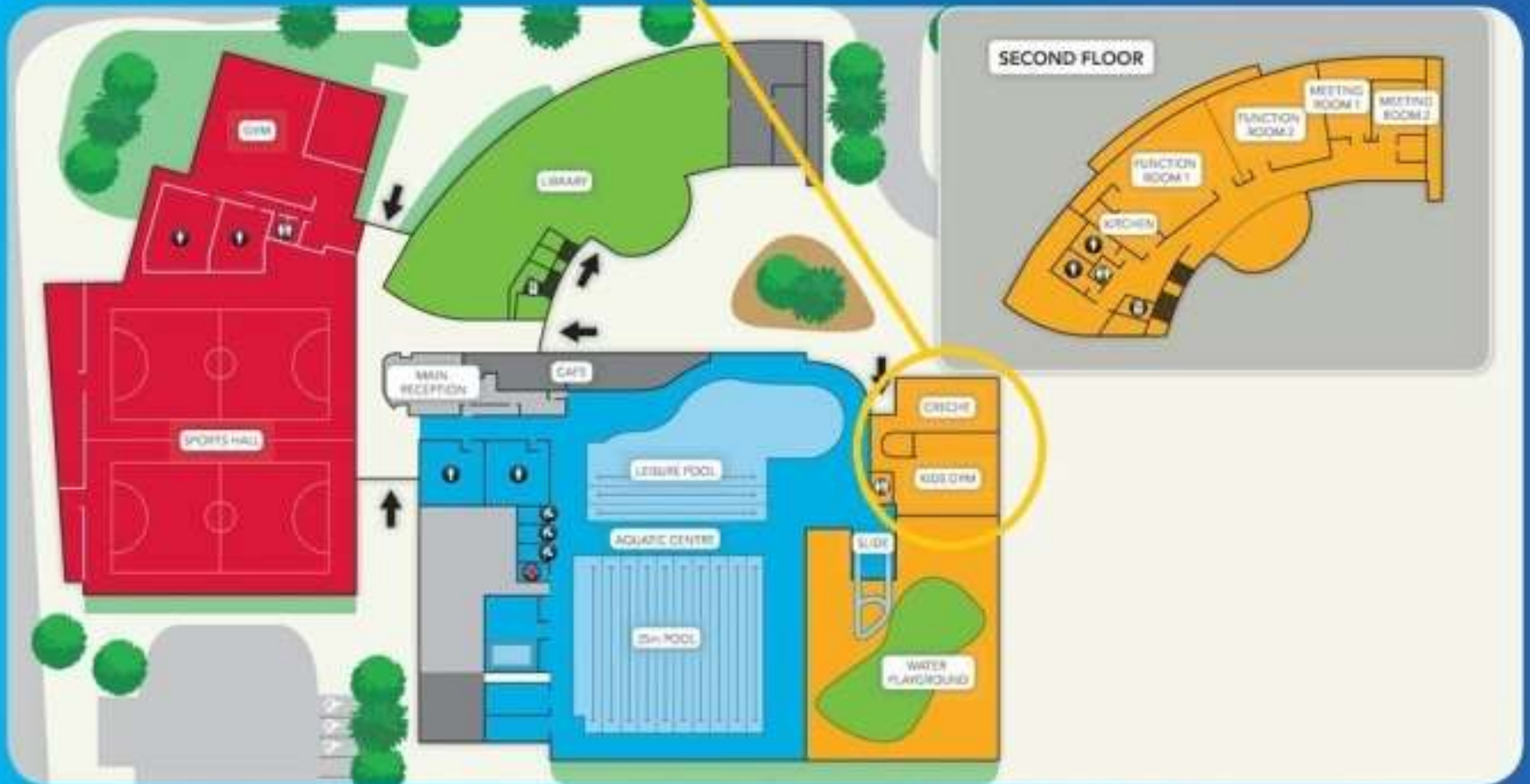

# OUTDOOR WATER PLAYGROUND 28°C

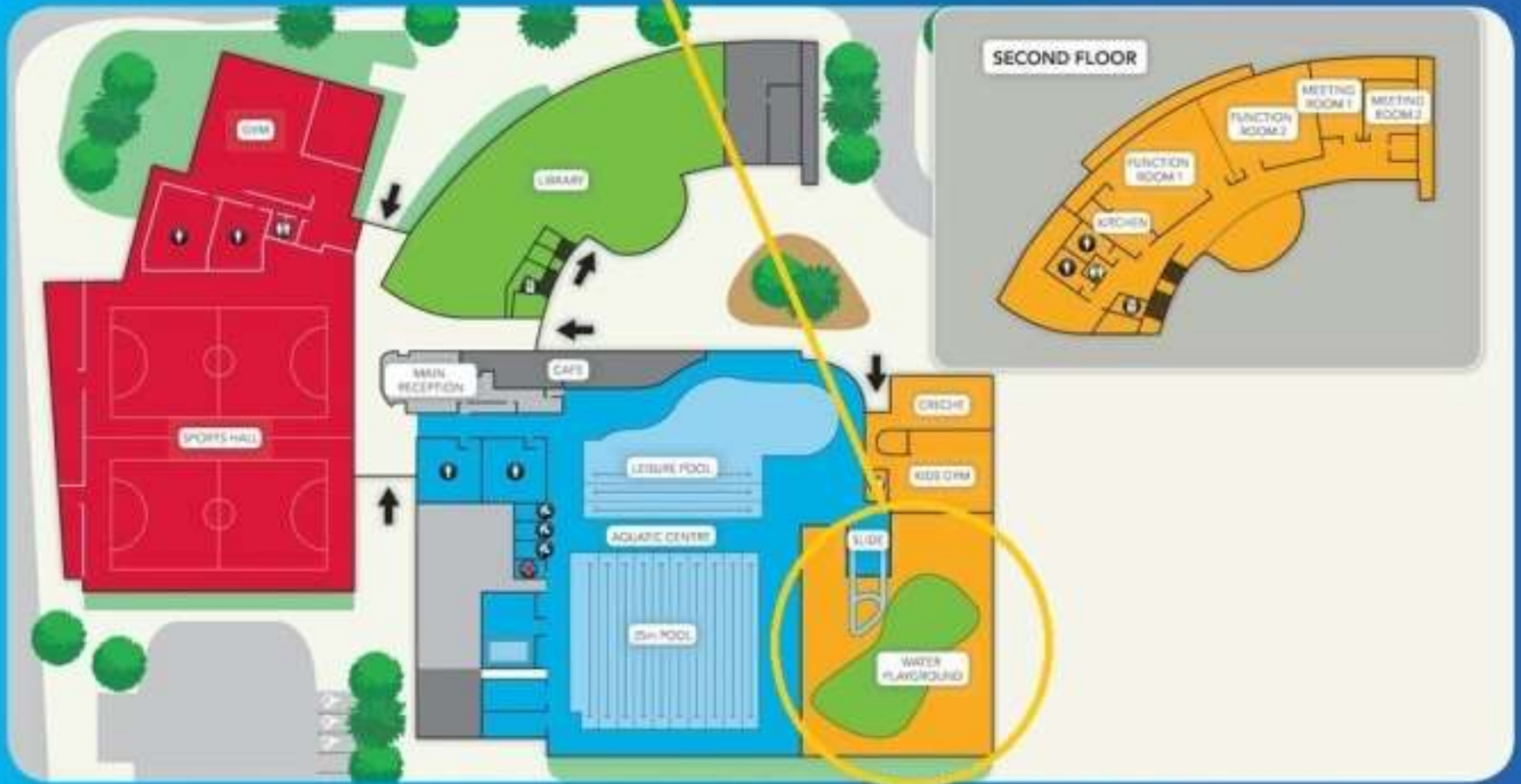



**POOL HALL**  
32°C POOL, 28°C POOL  
28°C HALL

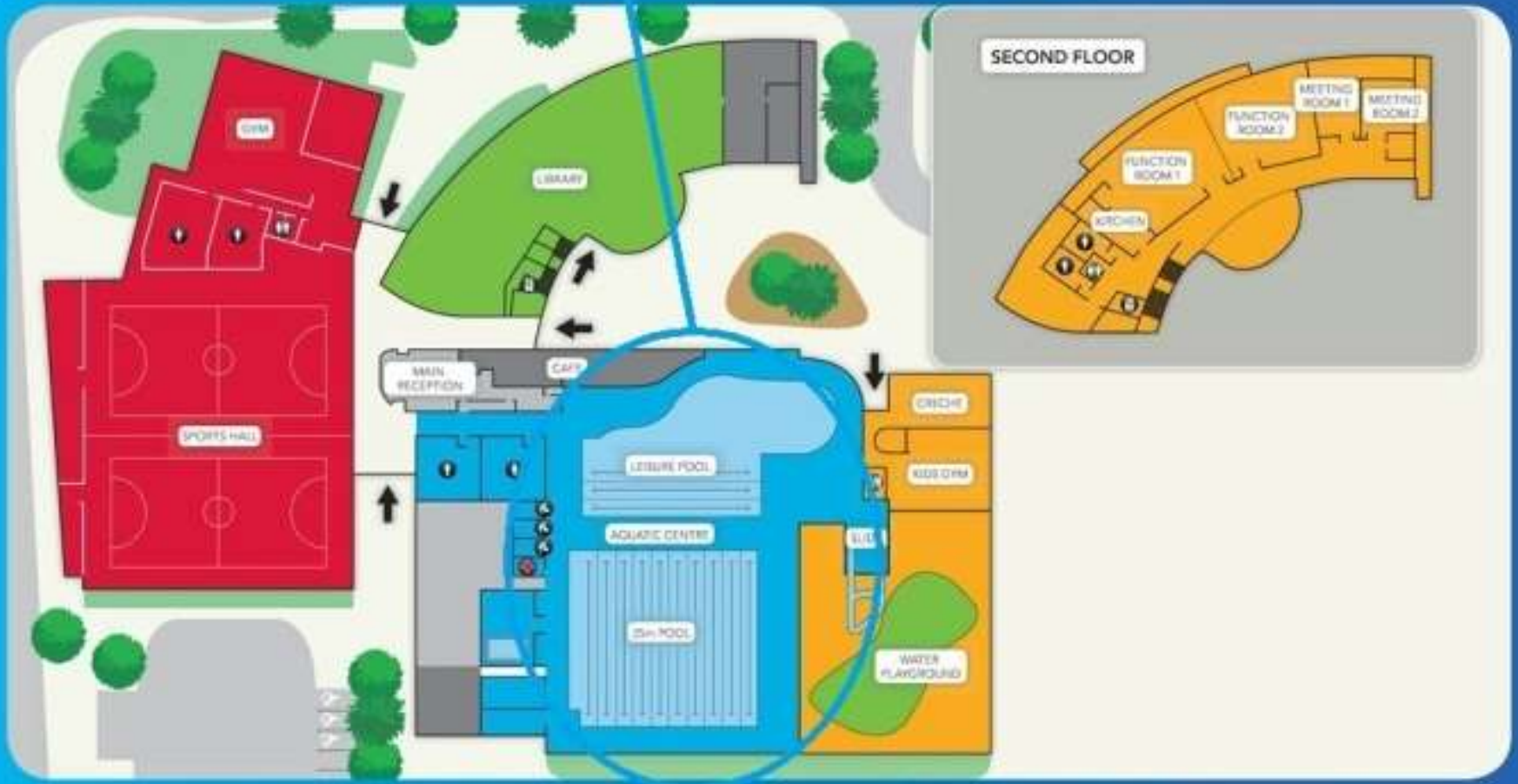

# WELLNESS CENTRE

36°C SPA, 38°C ROOM

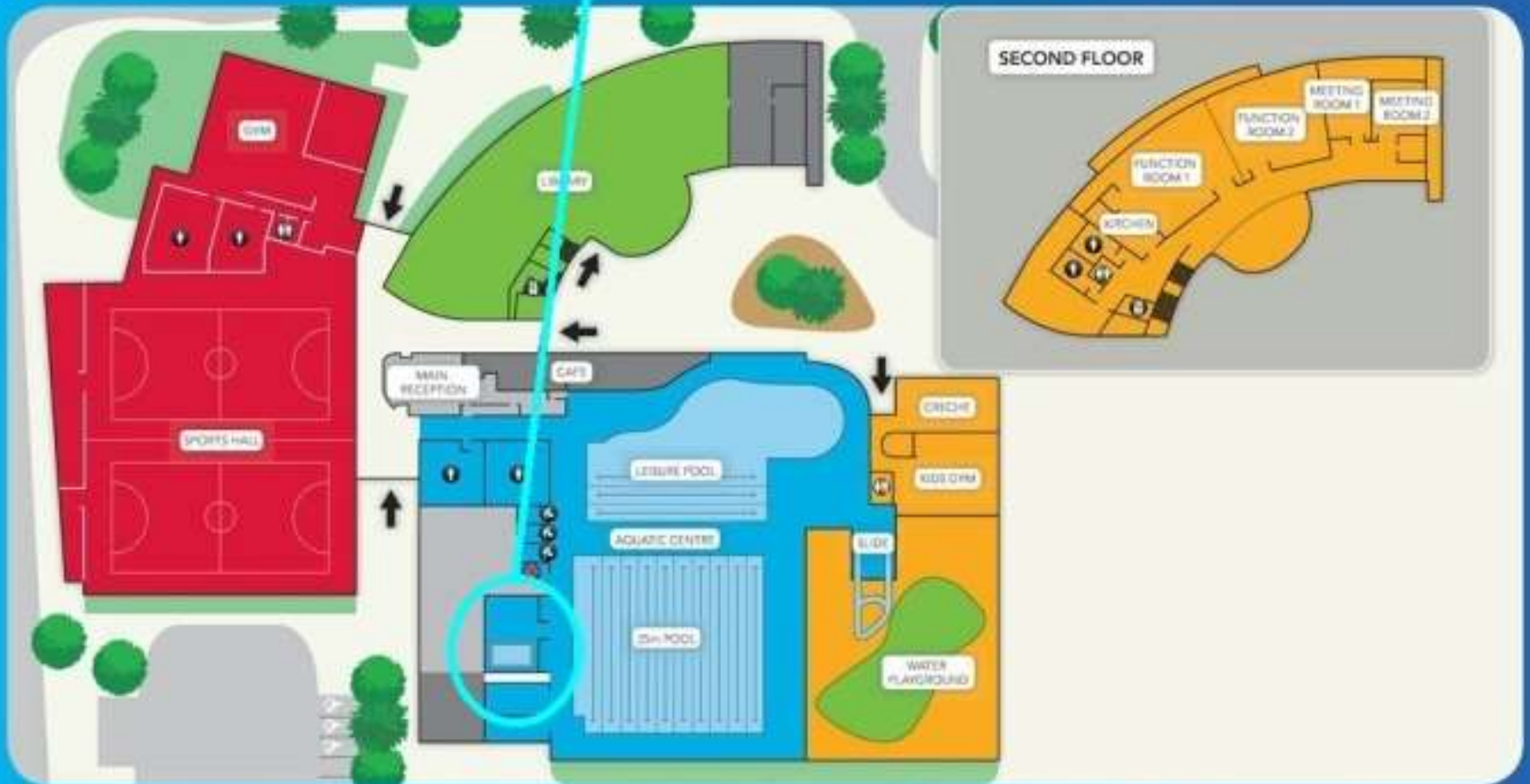

OFFICES / CAFE

23°C

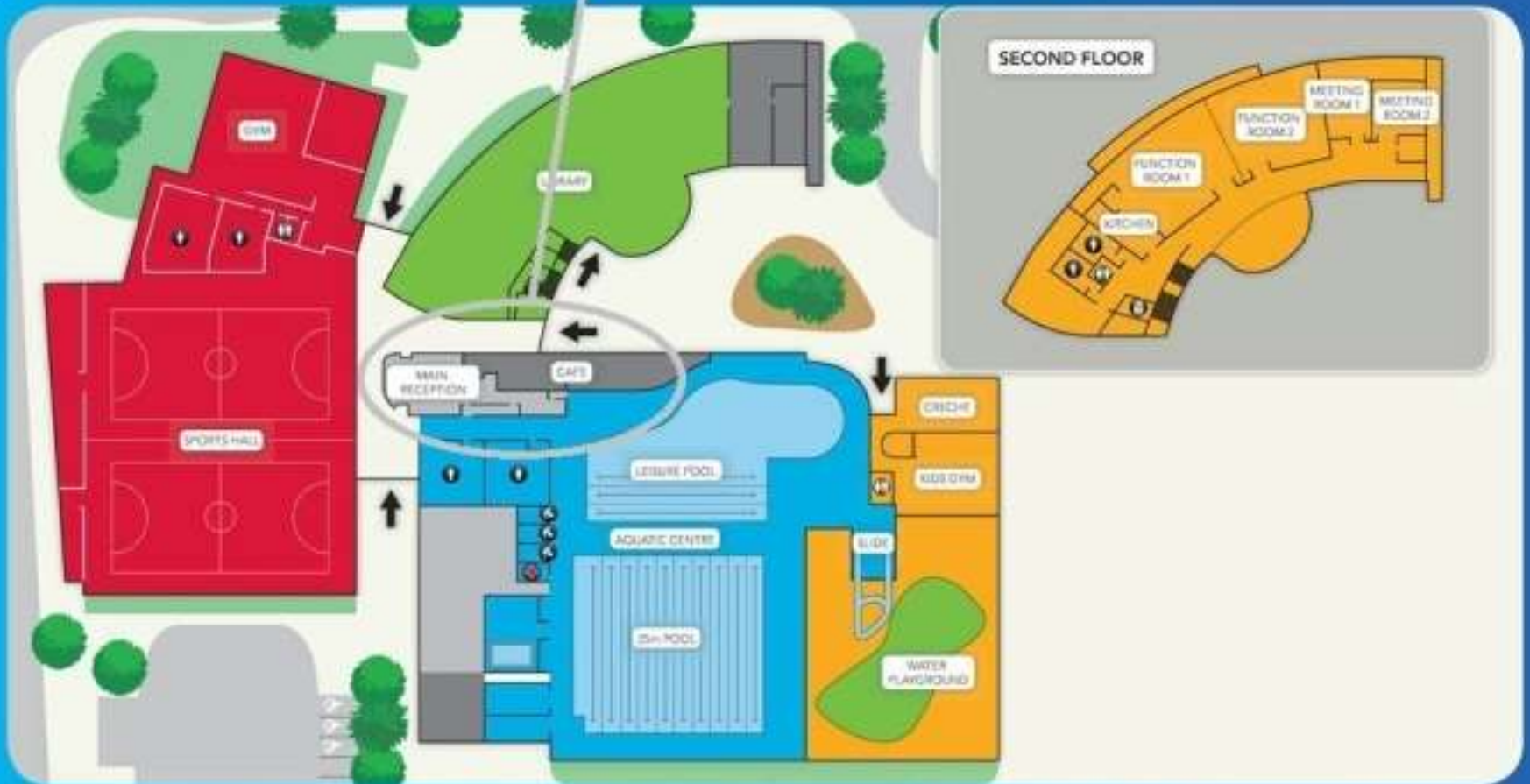

# Heat recovery operation mode

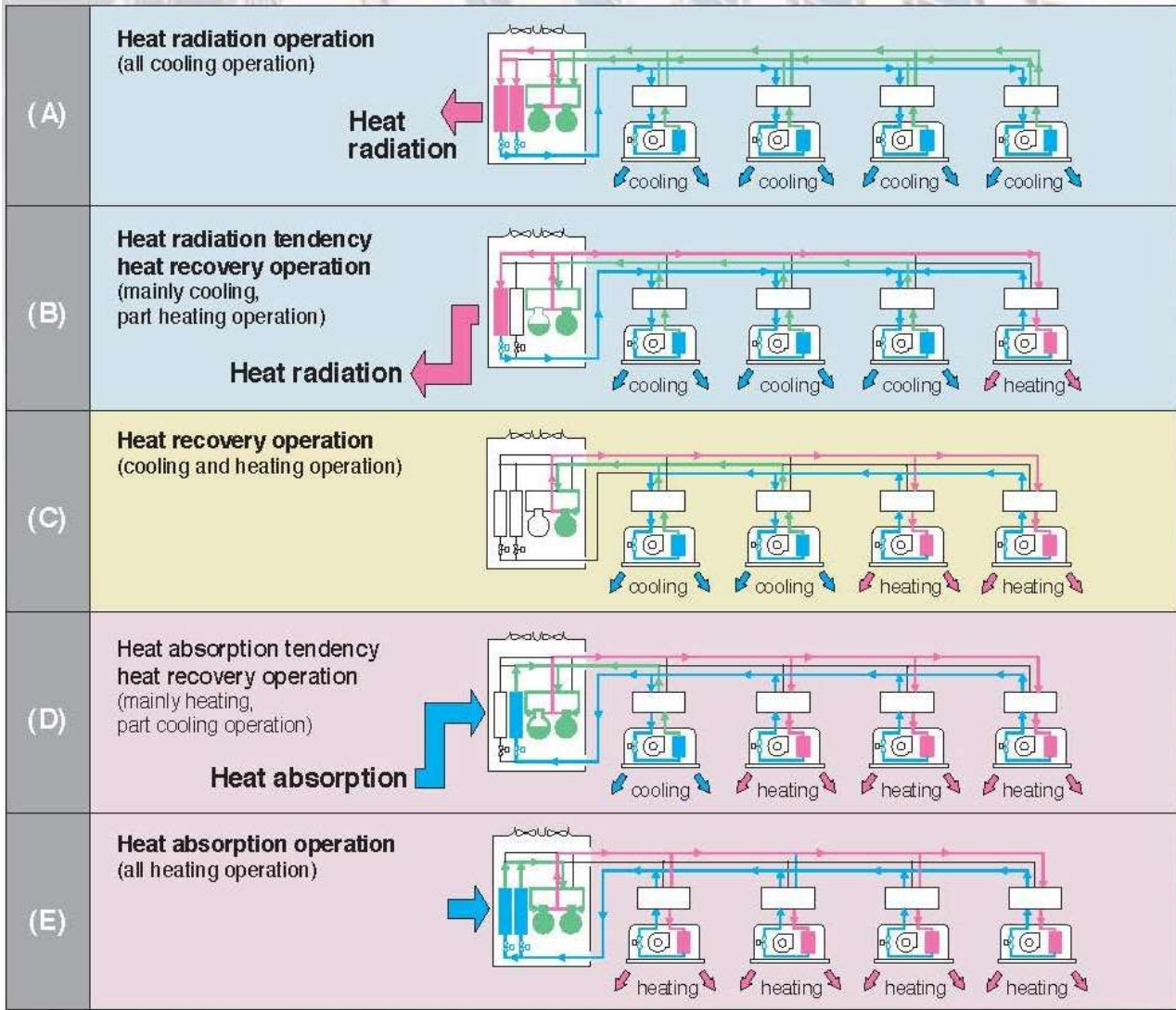
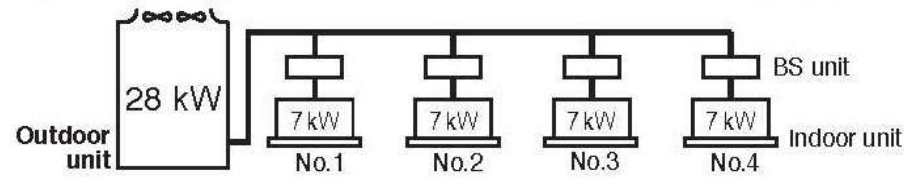

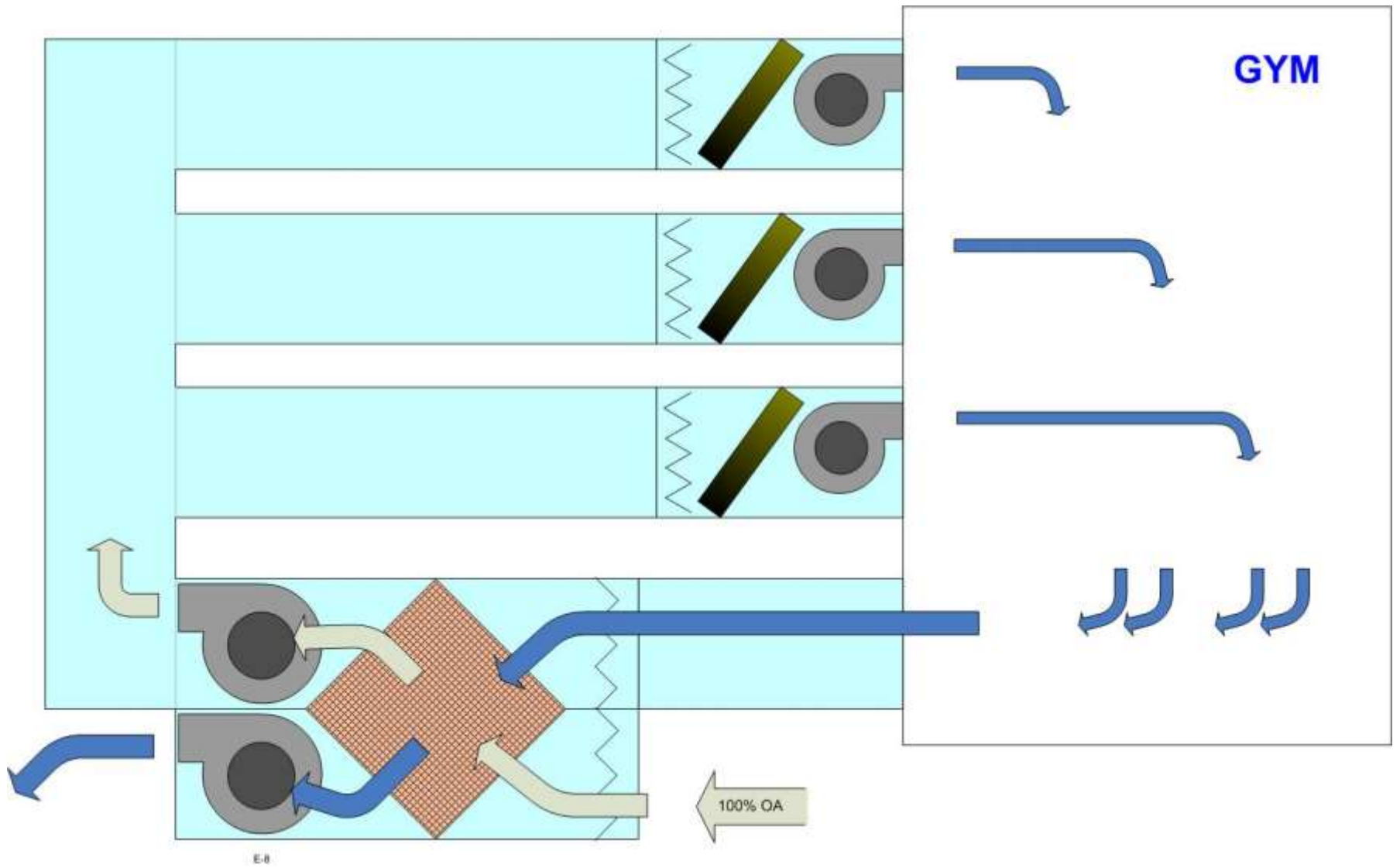

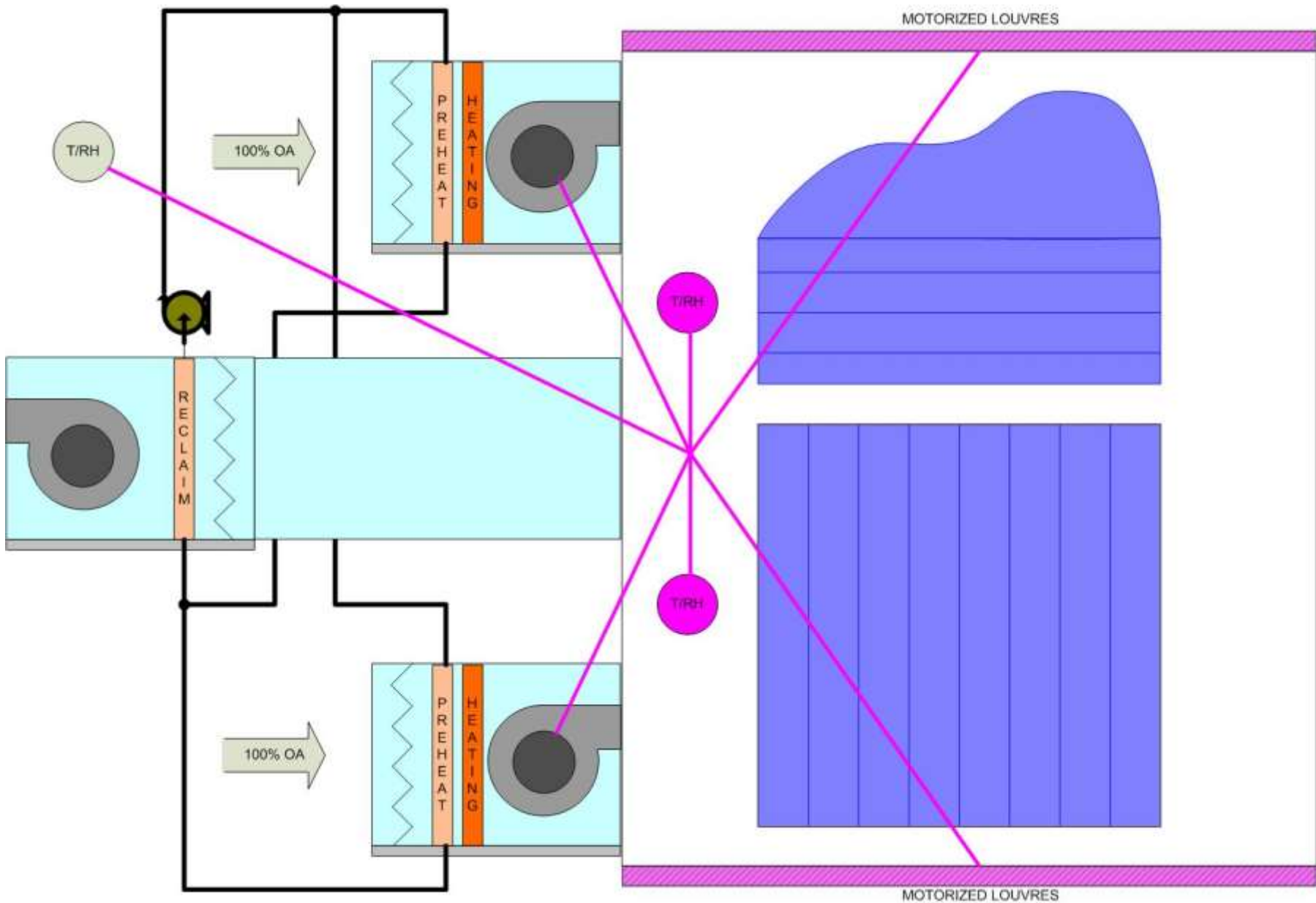

# Canning Leisure Centre

## Geothermal Heat Rejection

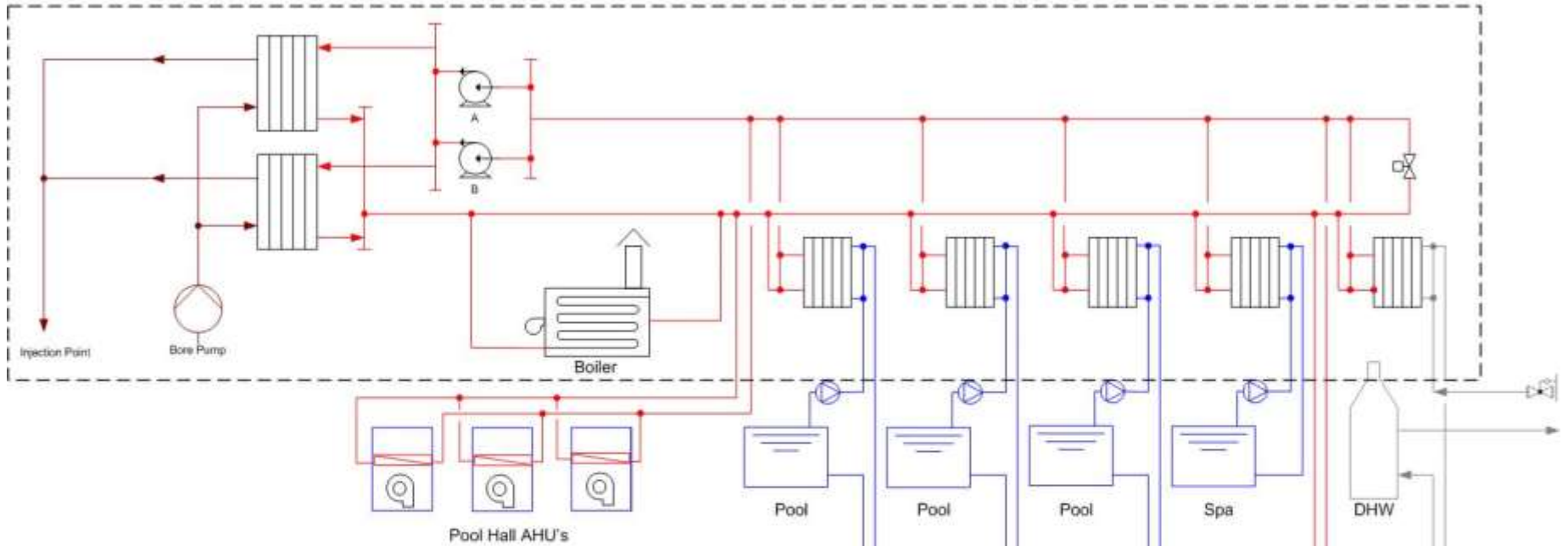

## Condenser Heat Rejection

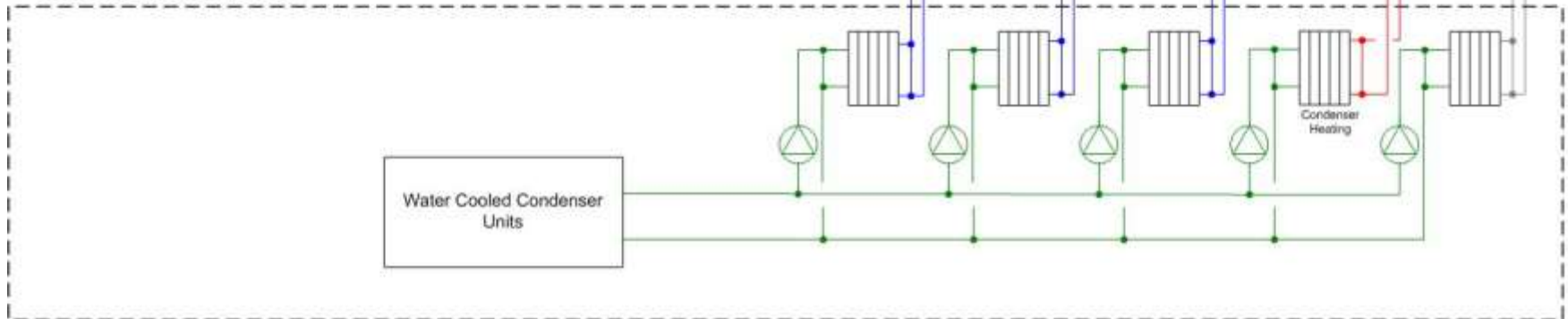

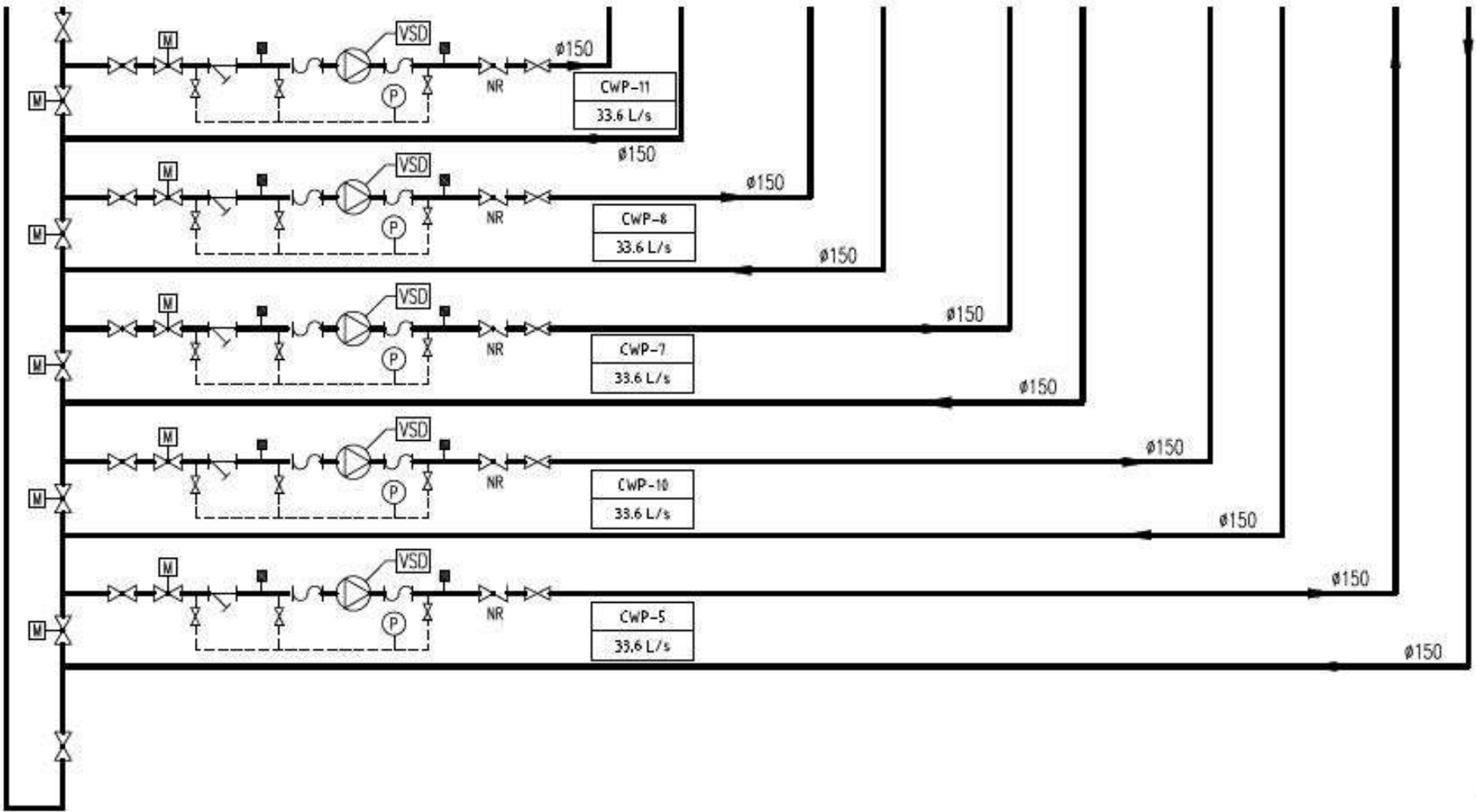



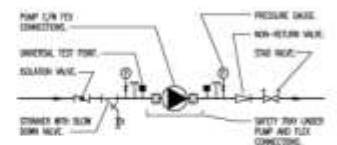
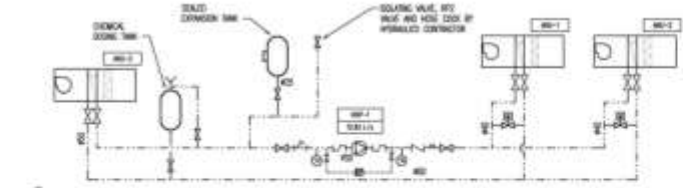
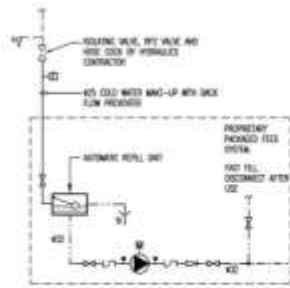

LOW TEMPERATURE INVENTORY RECLAIM COIL SCHEMATIC  
REF TO SCALE

TYPICAL PUMP ARRANGEMENT DETAIL  
REF TO SCALE

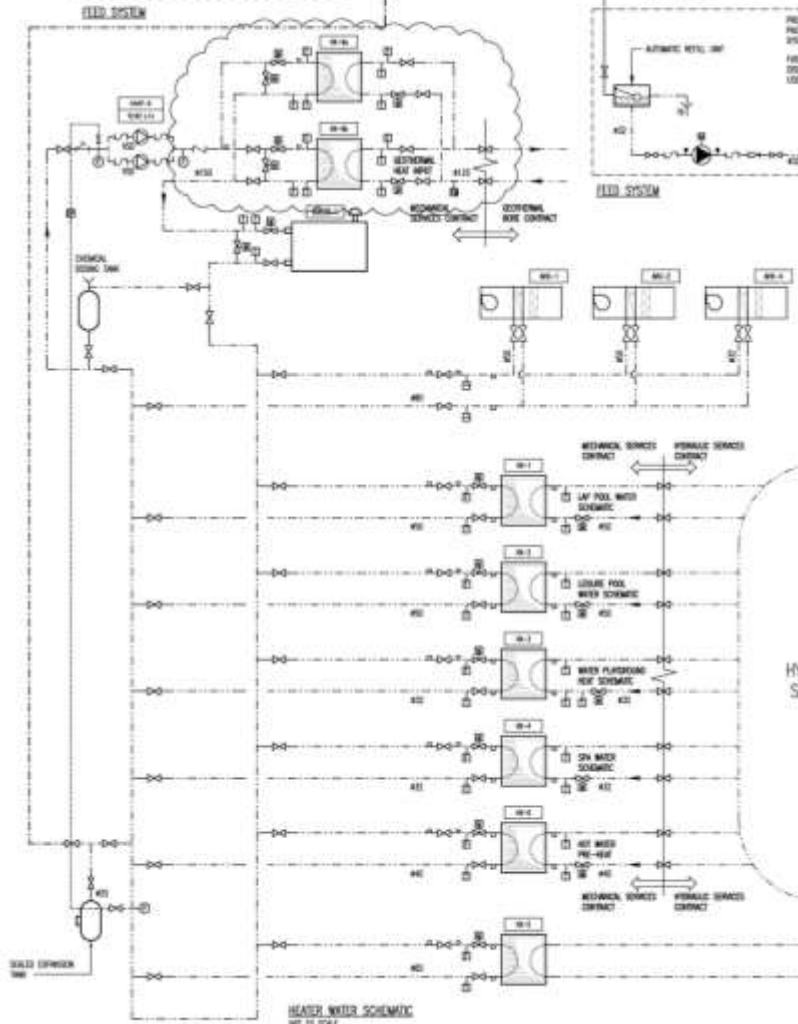

HEATER WATER SCHEMATIC  
REF TO SCALE

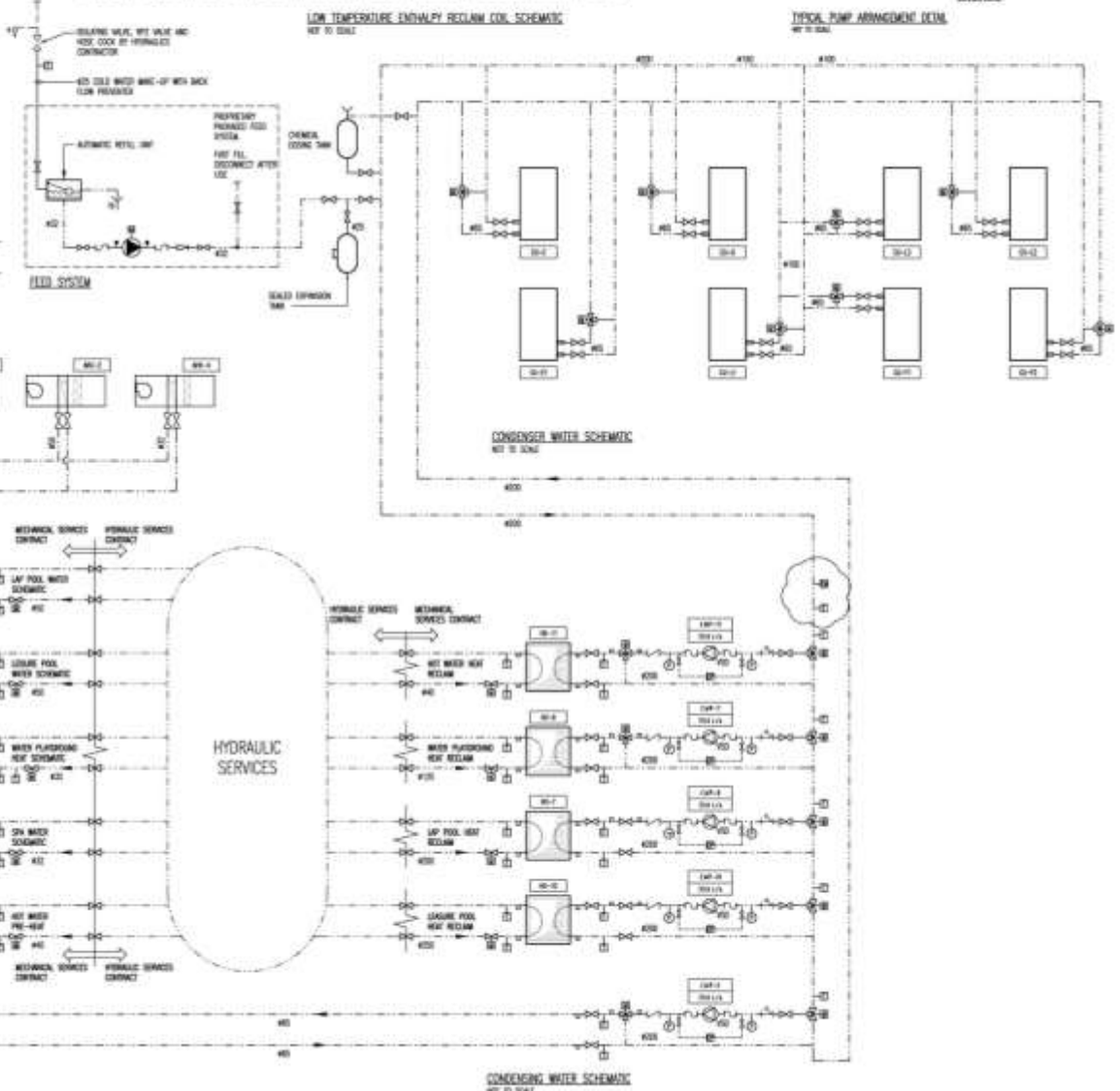

CONDENSER WATER SCHEMATIC  
REF TO SCALE

CONDENSING WATER SCHEMATIC  
REF TO SCALE

